

Micro Motion™ H-Series Hygienic Coriolis Flow and Density Meters



High accuracy real world performance

- Best-in-class performance on liquid mass flow, volume flow, and density measurements in a compact design (up to $\pm 0.05\%$ liquid mass accuracy and up to ± 0.5 kg/m³ liquid density accuracy)
- Superior sensitivity in a compact design to reduce variability in process control
- Rugged design minimizing process, mounting, and environmental effects

Best fit-for-application

- Cleanable, self-draining design for critical process control service
- Compact design enables installation flexibility
- Broad range of I/O offerings including HART™, Profibus-DP, FOUNDATION™ fieldbus, 4-20 mA, and wireless capabilities

Exceptional reliability and safety

- No moving parts to wear or replace minimizes maintenance for long-term reliability
- 316L stainless steel wetted parts construction with up to a 15 Ra surface finish for hygienic compatibility
- Robust sensor design

Micro Motion H-Series hygienic flow and density meters

Micro Motion H-Series meters deliver superb measurement with exceptional flow and density performance as well as outstanding reliability in a compact hygienic design for use in sanitary process control environments.

Optimal flow and density fit for hygienic process control applications

- High performance rugged measurement in a compact self-draining design
- Low frequency, high sensitivity fit-and-forget meter provides robust measurements even under demanding process conditions
- Multiple line sizes provide an ideal platform for batching, distribution, allocation and intra-plant measurement applications

Smart Meter Verification™: advanced diagnostics for your entire system

- Included as standard, with the option to license flow range detection and other advanced meter health diagnostics
- A comprehensive test that can be scheduled, run locally, or from the control room to provide confidence in your meter functionality and performance
- Verifies that your meter performs as well as the day it was installed, giving you assurance in less than 90 seconds
- Saves significant expenditure by reducing labor and extending or eliminating calibration intervals without interrupting the process

Industry-leading capabilities that unleash your process potential

- Available with the most extensive offering of transmitter and mounting options for maximum compatibility with your system
- State of the art, ISO/IEC 17025 compliant calibration stands achieving $\pm 0.014\%$ uncertainty drive best in class measurement accuracy
- The most robust communication protocol offering in the industry including Smart Wireless
- True multi-variable technology measures necessary flow and density process variables simultaneously

Widest range of installation and process condition flexibility

- Featuring a low pressure drop, low weight design that reduces installation and commissioning costs
- Unmatched MVD™ transmitter technology with digital signal processing (DSP) delivers the fastest response rates enabling accurate batch and process measurement
- Design flexibility enables operation in SIP, CIP and sanitary where 3-A and EHEDG compliance is required

Measurement principles

As a practical application of the Coriolis effect, the Coriolis mass flow meter operating principle involves inducing a vibration of the flow tube through which the fluid passes. The vibration, though it is not completely circular, provides the rotating reference frame which gives rise to the Coriolis effect. While specific methods vary according to the design of the flow meter, sensors monitor and analyze changes in frequency, phase shift, and amplitude of the vibrating flow tubes. The changes observed represent the mass flow rate and density of the fluid.

Mass and volume flow measurement

The measuring tubes are forced to oscillate producing a sine wave. At zero flow, the two tubes vibrate in phase with each other. When flow is introduced, the Coriolis forces cause the tubes to twist resulting in a phase shift. The time difference between the waves is measured and is directly proportional to the mass flow rate. Volume flow rate is calculated from mass flow rate and the density measurement.

Watch this video to learn more about how a Coriolis flow meter measures mass flow and density (click the link and select **View Videos**): <https://www.emerson.com/en-us/automation/measurement-instrumentation/flow-measurement/coriolis-flow-meters>.

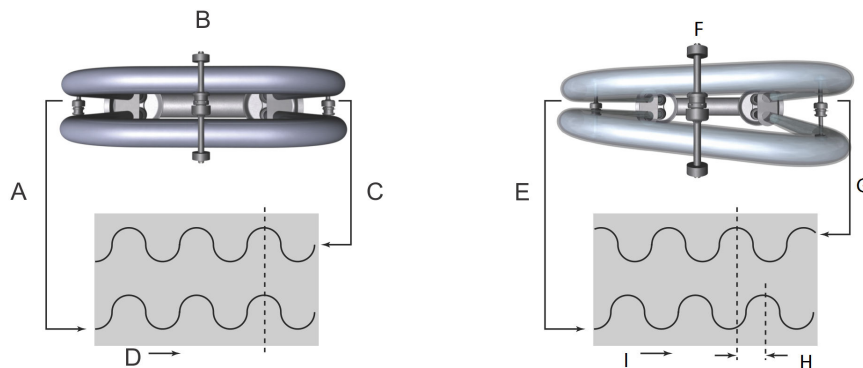

- A. Inlet pickoff displacement
- B. No flow
- C. Outlet pickoff displacement
- D. Time
- E. Inlet pickoff displacement
- F. With flow
- G. Outlet pickoff displacement
- H. Time difference
- I. Time

Density measurement

The measuring tubes are vibrated at their natural frequency. A change in the mass of the fluid contained inside the tubes causes a corresponding change to the tube natural frequency. The frequency change of the tube is used to calculate density.

Temperature measurement

Temperature is a measured variable that is available as an output. The temperature is also used internal to the sensor to compensate for temperature influences on Young's Modulus of Elasticity.

Meter characteristics

- Measurement accuracy is a function of fluid mass flow rate independent of operating temperature, pressure, or composition. However, pressure drop through the sensor is dependent upon operating temperature, pressure, and fluid composition.
- Specifications and capabilities vary by model and certain models may have fewer available options. For detailed information regarding performance and capabilities, either contact customer service or visit www.emerson.com/flowmeasurement.
- The letter at the end of the base mode code (for example, H100S) represents wetted part material S = 316L stainless steel 32 Ra finish (0.8 μm) and F = 316L stainless steel 15 Ra finish (0.4 μm).

Performance specifications

Reference operating conditions

For determining the performance capabilities of our meters, the following conditions were observed/used:

- Water at 68 °F (20.0 °C) to 77 °F (25.0 °C) and 14.5 psig (1.000 barg) to 29 psig (2.00 barg)
- Accuracy based on industry leading accredited calibration stands according to ISO/IEC 17025
- All models have a density range up to 3 g/cm³ (3,000 kg/m³)

Accuracy and repeatability

Accuracy and repeatability on liquids and slurries

Performance specifications	Premium	Enhanced	Basic
Mass and volume flow ⁽¹⁾⁽²⁾	±0.05%	±0.1%	±0.15%
Mass and volume repeatability ⁽¹⁾	0.025%	0.05%	0.075%
Density accuracy ⁽¹⁾	±0.0005 g/cm ³ (±0.5 kg/m ³)	±0.001 g/cm ³ (±1 kg/m ³)	±0.002 g/cm ³ (±2 kg/m ³)
Density repeatability ⁽¹⁾	±0.0002 g/cm ³ (±0.2 kg/m ³)	±0.0005 g/cm ³ (±0.5 kg/m ³)	±0.001 g/cm ³ (±1 kg/m ³)
Temperature accuracy	±1 °C ±0.5% of reading		
Temperature repeatability	±0.2 °C		

(1) Not available on all models.

(2) Stated flow accuracy includes the combined effects of repeatability, linearity, and hysteresis.

Accuracy and repeatability on gases

Performance specification	H050S/F, H100S/F, H200S/F, and H300S/F	H025S/F
Mass flow accuracy ⁽¹⁾	±0.35% of rate	±0.5% of rate
Mass flow repeatability ⁽¹⁾	±0.175% of rate	±0.25% of rate

Performance specification	H050S/F, H100S/F, H200S/F, and H300S/F	H025S/F
Temperature accuracy	±1 °C ±0.5% of reading	
Temperature repeatability	±0.2 °C	

(1) Stated flow accuracy includes the combined effects of repeatability, linearity, and hysteresis

Warranty

Warranty options on all H-Series models

The warranty period is generally initiated from the day of shipment. For warranty details, see the *Terms and Conditions* included with the standard product quote.

Base model	Included as standard	Included with startup service	Available for purchase
H025-300 (S/H/A/B/P)	18 months	36 months	> 36 months (customizable length)

Liquid flow rates

Nominal flow rate

Micro Motion has adopted the term *nominal flow rate*, which is the flow rate at which water at reference conditions causes approximately 14.5 psig (1 barg) of pressure drop across the meter.

Mass flow rates for all models

Model	Nominal line size		Nominal flow rate		Maximum flow rate	
	inch	mm	lb/min	kg/h	lb/min	kg/h
H025	.25 in to .50 in	DN6 to DN13	50	1336	100	2,720
H050	.50 in to 1 in	DN13 to DN25	155	4226	300	8,160
H100	1 in to 2 in	DN25 to DN50	717	19,510	1,200	32,650
H200F	2 in to 3 in	DN50 to DN80	1,134	30,857	2,350	63,960
H200S	2 in to 3 in	DN50 to DN80	2,187	59,520	3,200	87,100
H300	3 in to 4 in	DN80 to DN100	4,900	133,356	8,744	238,499

Volume flow rates for all models

Model	Nominal flow rate			Maximum flow rate		
	gal/min	barrels/h	l/h	gal/min	barrels/h	l/h
H025	6	9	1,366	12	18	2,720
H050	19	27	4,226	36	52	8,160
H100	86	123	19,510	144	206	32,650
H200F	136	194	30,857	384	550	87,100

Model	Nominal flow rate			Maximum flow rate		
	gal/min	barrels/h	l/h	gal/min	barrels/h	l/h
H200S	262	374	59,520	384	550	87,100
H300	587	839	133,356	1,047	1,497	238,499

Gas flow rates

Gas flow rates

When selecting sensors for gas applications, pressure drop through the sensor is dependent upon operating temperature, pressure, and fluid composition. Therefore, when selecting a sensor for any particular gas application, it is highly recommended that each sensor be sized using the Online Store Sizing and Selection Tool at www.emerson.com/flowmeasurement.

Gas flow rates for all models

For general recommendations on nominal and maximum gas mass flow rates a Mach number of 0.2 or 0.3, respectively, use the gas being measured. The Sizing and Selection Tool will report both the actual velocity and the sonic velocity for each flow rate and meter size considered. The ratio of actual velocity divided by sonic velocity reflects the Mach number, or alternatively, the mass flow rate to match a particular Mach number can be calculated with the following formula:

$$\dot{m}_{(gas)} = \%M * \rho_{(gas)} * VOS * \frac{1}{4} \pi * D^2 * 2 \text{ (for sensors with dual-tube design)}$$

$\dot{m}_{(gas)}$	Gas mass flow rate
$\%M$	Use Mach number “0.2” for calculating typical nominal rate; use Mach number “0.3” for calculating maximum recommended rate
$\rho_{(gas)}$	Gas density at operating conditions
VOS	Velocity of Sound of the measured gas
D	Internal diameter of the measuring tube

For a complete list of sensor tube IDs, see the *Micro Motion H-Series Hygienic Coriolis Flow and Density Meters Technical Data Sheet*.

Note

Gas maximum flow rate can never be greater than the liquid maximum rate; the lower of the two values should be assumed as applicable.

Sample calculation

The following calculation is an example of the maximum recommended gas mass flow rate for an H300S measuring natural gas with a molecular weight of 19.5 at 60 °F (16 °C) and 500 psig (34.47 barg):

$$\dot{m}_{(gas)} = 0.3 * 24(kg/m^3) * 430(m/s) * \frac{1}{4} \pi * .040m^2 * 2$$

$$\dot{m}_{(gas)} = 28,012 \text{ kg/hr; maximum recommended rate for H300S with natural gas at given conditions}$$

$\%M$	0.3 (used for calculating maximum recommended rate)
Gas density	24 kg/m ³
$VOS_{(NG)}$	430 m/s (Velocity of Sound of natural gas at given conditions)
H300S tube ID	40 mm

Zero stability

Zero stability is used when the flow rate approaches the low end of the flow range where the meter accuracy begins to deviate from the stated accuracy rating, as depicted in the turndown section. When operating at flow rates where meter accuracy begins to deviate from the stated accuracy rating, accuracy is governed by the formula: $\text{accuracy} = (\text{zero stability}/\text{flow rate}) \times 100\%$. Repeatability is similarly affected by low flow conditions.

Turndown capabilities

The graph and table below represent an example of the measurement characteristics under various flow conditions. At flow rates requiring large turndowns (greater than 20:1), the zero stability values may begin to govern capability dependent upon flow conditions and meter in use.

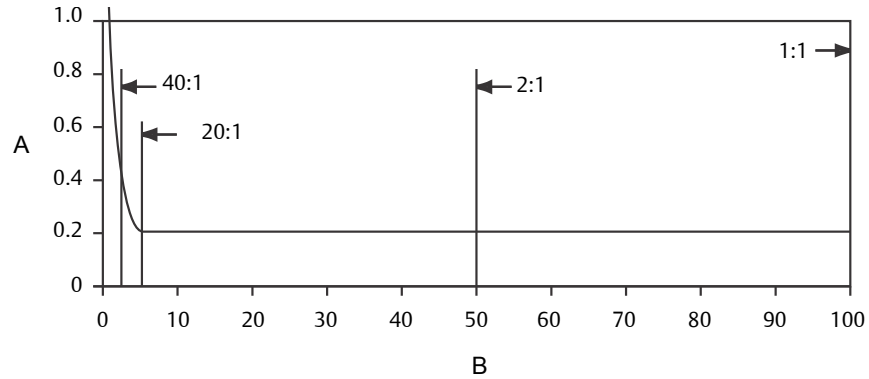

A. Accuracy, %
 B. Flow rate, % of nominal

Turndown from nominal flow rate	40:1	20:1	2:1
Accuracy	0.26	0.10	0.10
Pressure drop	0.1 psig (0.007 barg)	0.45 psig (0.0310 barg)	14.2 psig (0.979 barg)

Zero stability for all models

Model	Zero stability	
	lb/min	kg/h
H025	0.001	0.03
H050	0.005	0.136
H100	0.009	0.245
H200	0.065	1.769
H300	0.33	9.0

Process pressure ratings

Sensor maximum working pressure reflects the highest possible pressure rating for a given sensor. Process connection type and environmental and process fluid temperatures may reduce the maximum rating. For common sensor and fitting combinations, see the *Micro Motion H-Series Hygienic Coriolis Flow and Density Meters Technical Data Sheet*.

All sensors comply with Council Directive 2014/68/EU on pressure equipment.

Model	Maximum working pressure
H025F, H050F, H100F, H200F, H300F	1,015 psig (70 barg)
H025S, H050S, H100S, H200S, H300S	1,450 psig (100 barg)

Case pressure

Model	Case maximum pressure	Typical burst pressure
H025	471 psig (32 barg)	1,884 psig (130 barg)
H050	383 psig (26 barg)	1,530 psig (105 barg)
H100	320 psig (22 barg)	1,281 psig (88 barg)
H200	190 psig (13 barg)	760 psig (52 barg)
H300	417 psig (29 barg)	1,668 psig (115 barg)

Operating conditions: Environmental

Vibration limits

Meets IEC 60068-2-6, endurance sweep, 5 to 2000 Hz up to 1.0 g.

Temperature limits

Sensors can be used in the process and ambient temperature ranges shown in the temperature limit graphs. For the purposes of selecting electronics options, temperature limit graphs should be used only as a general guide. If your process conditions are close to the gray area, consult with your Micro Motion representative.

Note

- In all cases, the electronics cannot be operated where the ambient temperature is below -40 °F (-40.0 °C) or above 140 °F (60.0 °C). If a sensor is to be used where the ambient temperature is outside of the range permissible for the electronics, the electronics must be remotely located where the ambient temperature is within the permissible range, as indicated by the shaded areas of the temperature limit graphs.
- Temperature limits may be further restricted by hazardous area approvals. Refer to the hazardous area approvals documentation shipped with the sensor or available from the www.emerson.com/flowmeasurement. For further questions, contact customer service.
- The extended-mount electronics option allows the sensor case to be insulated without covering the transmitter, core processor, or junction box, but does not affect temperature ratings. When insulating the sensor case at elevated process temperatures (above 140 °F (60.0 °C)), please ensure electronics are not enclosed in insulation as this may lead to electronics failure.

Ambient and process temperature limits for all H-Series meters

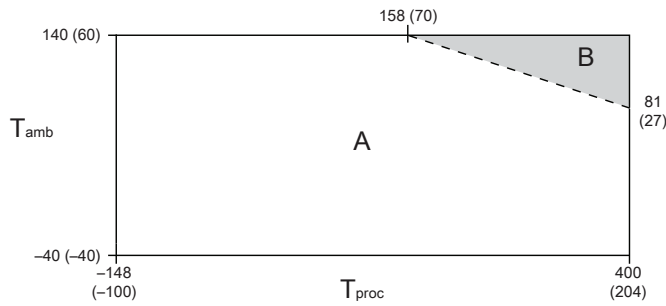

- A. All available electronic options
- B. Extended or remote mount electronics only

T_{amb} Ambient temperature °F (°C)

T_{proc} Process temperature °F (°C)

Operating conditions: Process

Process pressure effect

Process pressure effect is defined as the change in sensor flow and density accuracy due to process pressure change away from the calibration pressure. This effect can be corrected by dynamic pressure input or a fixed meter factor. For proper setup and configuration, see the *Micro Motion H-Series Hygienic Coriolis Flow and Density Meters Installation Manual*.

The following table shows the process pressure effect for all models: 316L stainless steel (S/F).

Model	Mass flow (% of rate)		Density	
	per psi	per bar	g/cm ³ per psi	kg/m ³ per bar
H025	None	None	None	None
H050	-0.0008	-0.0116	-0.00003	-0.435
H100	-0.0013	-0.01885	-0.00004	-0.58
H200	-0.0007	-0.01015	-0.00003	-0.435
H300	-0.0012	-0.0174	-0.000017	-0.2465

Process temperature effect

- For mass flow measurement, process temperature effect is defined as the change in sensor flow accuracy due to process temperature change away from the calibration temperature. Temperature effect can be corrected by zeroing at the process conditions.
- For density measurement, process temperature effect is defined as the change in sensor density accuracy due to process temperature change away from the calibration density. For proper setup and configuration, see the *Micro Motion H-Series Hygienic Coriolis Flow and Density Meters Installation Manual*.

Model code	Mass flow rate (% of maximum rate) per °C	Density	
		g/cm ³ per °C	kg/m ³ per °C
H025	±0.0007	±0.0001	±0.1
H050, H100, H200, H300	±0.0002	±0.0001	±0.1

Two-phase flow effect

NAMUR NE 132 guidelines state that, “Coriolis meters with a higher agitation frequency react more sensitively to gas bubbles in liquids when compared to devices with a lower agitation frequency.” For operating (agitation) frequency ranges for each model, see [Best practices: installing and selecting meters for two-phase flow](#).

Two-phase flow effects are governed by an increased decoupling ratio or a decreased Velocity of Sound (VoS) in the process fluid due to entrained gas, aeration, or the presence of liquid in gas. Following best practices regarding installation and meter selection can prevent or minimize measurement errors associated with two-phase flow effects.

Tip

For more details regarding the effects of two-phase flow on Coriolis meters, or performance expectations in these applications, see the *Entrained Gas Handling in Micro Motion Coriolis* white paper and any additional resources available at www.emerson.com/flowmeasurement.

Performance influences during two-phase flow conditions

Optimal meter performance during two-phase flow conditions is primarily governed by meter selection, flow regime, and fluid properties. Sample magnitudes of the effect are provided in the white paper referenced previously. The information in the following table provides common forms of influence quantities that can affect measurement performance during two-phase flow conditions.

Two-phase flow performance influence factors

Type of influence	Specific influence on measurement	Recommendation
VoS / fluid compressibility	Over-reading due to interaction between frequency of the acoustic and drive modes	Select a meter that operates in an ULTRA-LOW ⁽¹⁾ or LOW drive frequency range to avoid VoS effects.
Decoupling	Under-reading as a result of bubble or particle movement with respect to the fluid	Increase fluid viscosity, decrease bubble size, or use a meter with lower drive frequency in order to minimize decoupling.
Signal processing noise	Ability to maintain signal accuracy during high noise conditions or rapid process changes	Select advanced electronics that use high-speed mass and density signal processing methods for effective noise rejection.

(1) See [Operating drive mode frequency range for all models](#).

Best practices: installing and selecting meters for two-phase flow

Flow sensor best practices:

- Ensure that the meter is sized correctly to maintain a flow rate greater than 5:1 turndown from nominal.
- Install the meter with the preferred orientation. For orientation based on fluid type, see the *Micro Motion H-Series Hygienic Coriolis Flow and Density Meters Installation Manual*.
- Select a meter design with the lowest available operating frequency.

Transmitter and electronics best practices:

- Enable multiphase severity alerts to accurately detect when two-phase flow is present.
- Select a meter with a real-time clock and historian capabilities to diagnose process events or upsets.
- Use Advanced Phase Measurement in intermittent high %GVF or %LVF installations where density or volume flow is required.

Operating drive mode frequency range for all models

Reference conditions: water at 14.7 psig (1.014 barg) and 60 °F (16 °C).

- ULTRA-LOW (<100 hz)** Preferred solution for installations with two-phase flow conditions
- LOW (100 - 150 hz)** Preferred solution for installations with two-phase flow conditions
- MID-RANGE (150 - 300 hz)** Suitable in some instances for installations with two-phase flow conditions
- HIGH (> 300 hz)** Not recommended for two-phase flow installations



Range	Model code
ULTRA-LOW (< 100 Hz)	See the <i>Micro Motion ELITE Coriolis Flow and Density Meters Product Data Sheet</i>
LOW (100-150 Hz)	See the <i>Micro Motion ELITE Coriolis Flow and Density Meters Product Data Sheet</i>
MID-RANGE (150-300 Hz)	H025, H050, H100, H200, H300
HIGH (> 300 Hz)	None

Viscosity range

For installations with 3 in (DN80) or larger meters, and fluid viscosities greater than 500 centistokes (cSt), consult your Micro Motion sales representative or technical support for guidance on optimizing your configuration. This recommendation is not applicable for smaller meters or processes with dynamic viscosities less than 500 cSt.

Hazardous area classifications

Approvals and certifications

Type	Approval or certification (typical)	
CSA and CSA C-US	Ambient temperature: -40 °F (-40.0 °C) to 140 °F (60.0 °C) Class I, Div. 2, Groups A, B, C, and D Class II, Div.2, Groups F and G	
ATEX		II 1(2) G Ex ib IIB/IIC T6.T1 Ga/Gb II 2 D Ex ib IIIC T* °C Db IP66/IP67
		II 3G Ex nA IIC T1-T4/T5 Gc II 3D Ex tc IIIC T*°C Dc IP66
IECEX	Ex ib IIIC T* °C Db Ex nA IIC T1-T4/T5 Gc Ex tc IIIC T* °C Dc	
	Ex ib IIB/IIC T1-T4/T5/T6 Gb. Note The H300 is Ex ib IIB; only with approval option code 7 it is Ex ib IIC.	
NEPSI	Ex ib IIB/IIC T1-T6 Gb Ex ibD 21 T450°C-T85°C Ex nA IIC T1-T6 Gc DIP A22 T* T1-T6	
Ingress Protection Rating	IP 66/67 for sensors and transmitters	
EMC effects	Complies with EMC directive 2004/108/EC per EN 61326 Industrial	
	Complies with NAMUR NE-21 (09.05.2012)	

Notes

- Approvals shown are for H-Series meters. Meters with integral electronics may have more restrictive approvals. For details, see the transmitter Product Data Sheet.
- When a meter is ordered with hazardous area approvals, detailed information is shipped along with the product.
- More information about hazardous approvals, including detailed specifications and temperature graphs for all meter configurations is available on the H-Series product page at www.emerson.com/flowmeasurement.

Industry standards

Type	Standard
Weights & Measures for custody transfer applications:	<ul style="list-style-type: none"> ▪ National Type Evaluation Program (NTEP) ▪ Measurement Canada

Type	Standard
Industry standards and commercial approvals	<ul style="list-style-type: none"> ■ NAMUR: NE132 (burst pressure, sensor flange to flange length), NE131 ■ Pressure Equipment Directive (PED) ■ Canadian Registration Number (CRN) ■ Dual Seal ■ ASME B31.3 Piping Code ■ SIL2 and SIL3 safety certifications
Hygienic approvals	<ul style="list-style-type: none"> ■ ASME BPE ■ EHEDG, 3A

Connectivity

H-Series sensors are highly customizable to provide a configuration that is tailor-fit to specific applications.

For help determining which Micro Motion products are right for your application, see the *Micro Motion Technical Overview and Specification Summary* and other resources at www.emerson.com/flowmeasurement.

Communication and diagnostic information

Transmitter interface

- Up to five fully configurable I/O channels, with options for 2-wire, Ethernet, and wireless communication
- Complete suite of mounting options to accommodate installation requirements – integral, remote, wall mount, and DIN rail
- Application software designed specific for your process – batching, concentration, and Advanced Phase Measurement

Diagnostic data

- Smart Meter Verification – checks the health and integrity of the meter’s tubes, electronics, and calibration without interrupting the process
- Zero verification – quickly diagnoses the meter to determine if re-zeroing is recommended, and if process conditions are stable and optimal for zeroing
- Multiphase detection – proactively identifies multiphase process conditions and severity
- Time-stamped digital audit trails and reports for optimized agency compliance









Communication protocols

Typical I/O connectivity options include:

- 4-20 mA
- HART
- 10k Hz pulse
- Wireless
- Ethernet
- Modbus
- FOUNDATION fieldbus
- PROFIBUS-PA
- PROFIBUS-DP
- Discrete I/O

Transmitter compatibility and primary attributes

For a complete list of all transmitter configurations and options, see the transmitter product data sheets and other resources available at www.emerson.com/flowmeasurement.

Model	Transmitter						
	1500/2500	1700/2700	2400S	3000 series	FMT	4200	5700
							
Flow meters							
H025, H050, H100	•	•	•	•	•	•	•
H200, H300	•	•	•	•		•	•
Power							
AC		•	•	•			•
DC	•	•	•	•	•		•
Loop powered (2-wire)						•	
Diagnostics							
SMV basic (included)	•	•	•	•		•	•
SMV Pro	•	•	•	•		•	•
Real time clock						•	•
Onboard data historian						•	•
Local operator interface							
2-line display		•	•				
Graphical display				•		•	•

Model	Transmitter						
	1500/2500	1700/2700	2400S	3000 series	FMT	4200	5700
Certifications and approvals							
SIS certified		•				•	•
Custody transfer		•		•			•

Physical specifications

Materials of construction

Do not rely on general corrosion guidelines for cyclical stress when choosing a wetted material for your H-Series meter. For material compatibility information, see the *Micro Motion Corrosion Guide*.

Wetted part materials

Model	316L stainless steel	Sensor weight
H025	•	13 lb (6 kg)
H050	•	15 lb (7 kg)
H100	•	23 lb (10 kg)
H200	•	42 lb (19 kg)
H300	•	105 lb (48 kg)

Notes

- Weight specifications are based upon ASME B16.5 CL150 flange and do not include electronics.
- Heat jackets and steam kits are also available.

Non-wetted part materials

Component	Enclosure rating	316L/CF-3M stainless steel	304L stainless steel	Polyurethane-painted aluminum
Sensor housing	—		•	
Core processor housing	NEMA 4X (IP66/67)	•		•
Junction box housing	NEMA 4X (IP66)	•		•
1700/2700 transmitter housing	NEMA 4X (IP66/69K)	•		•
3700 transmitter housing	NEMA 4X (IP66/67)			•
2400S transmitter housing	NEMA 4X (IP66/67/69K ⁽¹⁾)	•		•
2200S transmitter housing	NEMA 4X (IP66/67)	•		•

Component	Enclosure rating	316L/CF-3M stainless steel	304L stainless steel	Polyurethane-painted aluminum
4200 transmitter housing	NEMA 4X (IP66/67/69K)	•		•
5700 transmitter housing	NEMA 4X (IP66/67/69K)	•		•

(1) *Stainless steel version only.*

Flanges

Flange types for all sensor models:

- DIN11851, DIN11864-1A, DIN11864-2A, DIN11864-3A (up to DN80)
- IDF (Up to 3s)
- ISO 2853 (IDF) (DN76.1)
- Hygienic Tri-Clamp® compatible

Note

For more information about flange compatibility, contact customer support.

Dimensions

These dimensional drawings are intended to provide a basic guideline for sizing and planning. They are representative of a sensor fitted with a Tri-Clamp compatible flange and 2400 transmitter.

Face-to-Face (Dim. A, below) dimensions for all H-Series meters with each available process connection can be found in the *Micro Motion H-Series Hygienic Coriolis Flow and Density Meters Technical Data Sheet*.

For complete and detailed dimensional drawings, contact customer support.

Notes

- All dimensions are ±0.12 in (±3.0 mm)
 - Representative of a sensor fitted with a Tri-Clamp compatible flange and 2400 transmitter
-

Example dimensions for all models

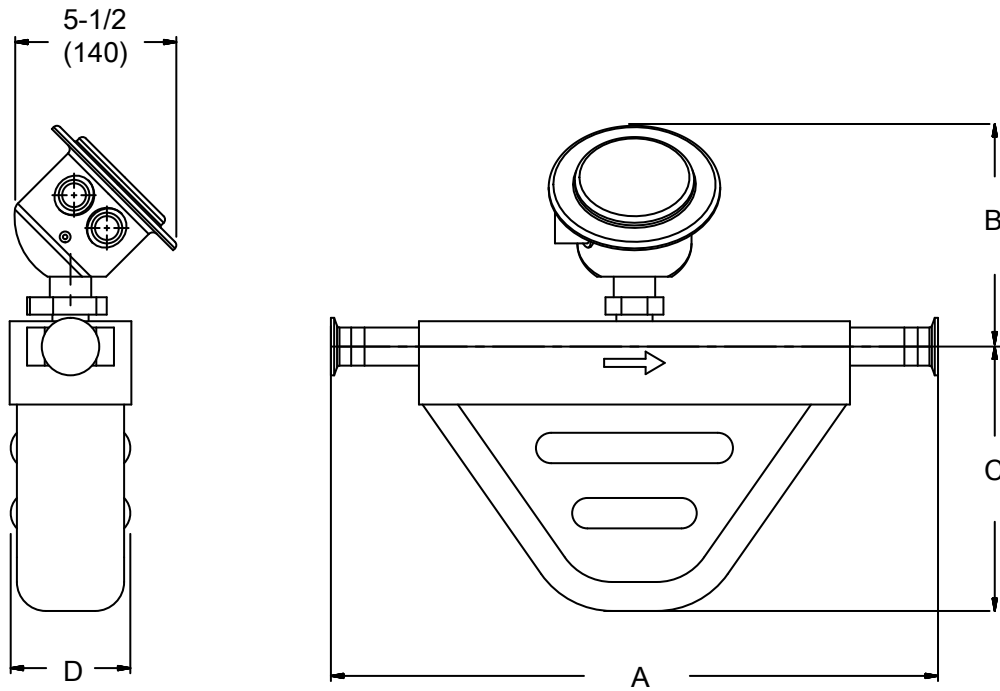

Model	Dim. A	Dim. B	Dim. C	Dim. D
H025	15.9 in (404 mm)	7.4 in (188 mm)	5.1 in (130 mm)	2.8 in (71 mm)
H050	17.4 in (442 mm)	7.4 in (188 mm)	6.7 in (170 mm)	3 in (76 mm)
H100	20.9 in (531 mm)	7.6 in (193 mm)	9.1 in (231 mm)	4.1 in (104 mm)
H200	21.3 in (541 mm)	8.5 in (216 mm)	12.6 in (320 mm)	5.6 in (142 mm)
H300	34.7 in (881 mm)	10.3 in (262 mm)	11.1 in (282 mm)	7.3 in (185 mm)

Ordering information

Use this section to select the correct ordering codes for your configuration.

Example model code

The sensor is shipped with a model code stamp so that after purchase, you can verify the ordering codes described in this section.



- A. Sensor and model
- B. Base model
- C. Process connection
- D. Case option
- E. Electronics interface
- F. Conduit connection
- G. Approval
- H. Language
- I. Additional standard approval
- J. Calibration
- K. Measurement application software
- L. Factory options
- M. Certificates, tests, calibrations, and services

Base model

Code descriptions

Codes S and F are model designations used to identify the type of meter.

Model	Material
S	316L stainless steel; 32 Ra finish (0.8 µm)
F	316L stainless steel; 15 Ra finish (0.4 µm)

Codes available by model

Model	Available codes	
	F	S
H025 .25 in (DN6)	F	S
H050 .5 in (DN15)	F	S
H100 1 in (DN25)	F	S
H200 2 in (DN50)	F	S
H300 3 in (DN80)	F	S

Process connections

Model H025

Code	Description				
121	.5 in	Tri-Clamp compatible	316L	Hygienic fitting	
222	DN15	DIN11851	316L	Hygienic coupling	
665	8A	IDF	316L	Hygienic fitting	Type CLF W
676	DN15	DIN11864-1A	316L	Aseptic connection	
C70	DN15	DIN11864-2A	316L	Hygienic flange	
C80	DN15	DIN11864-3A	316L	Hygienic flange	

Model H050

Code	Description				
222	DN15	DIN11851	316L	Hygienic coupling	
322	.75 in	Tri-Clamp compatible	316L	Hygienic fitting	
667	15A	IDF	316L	Hygienic fitting	Type CLF W
676	DN15	DIN11864-1A	316L	Aseptic connection	
C70	DN15	DIN11864-2A	316L	Hygienic flange	
C80	DN15	DIN11864-3A	316L	Hygienic flange	

Model H100

Code	Description				
138	1 in	Tri-Clamp compatible	316L	Hygienic fitting	
230	DN25	DIN11851	316L	Hygienic coupling	
668	1s	IDF	316L	Hygienic fitting	Type CLF2 W
677	DN25	DIN11864-1A	316L	Aseptic connection	
C71	DN25	DIN11864-2A	316L	Hygienic flange	
C81	DN25	DIN11864-3A	316L	Hygienic flange	
C84	DN40	DIN11864-2A	316L	Hygienic flange	
C85	DN40	DIN11864-3A	316L	Hygienic flange	

Model H200

Code	Description				
352	2 in	Tri-Clamp compatible	316L	Hygienic fitting	
354	DN50	DIN11851	316L	Hygienic coupling	
669	2s	IDF	316L	Hygienic fitting	Type CLF2 W

Code	Description				
678	DN50	DIN11864-1A	316L	Aseptic connection	
C68	DN50	DIN 1864-3A	316L	Hygienic flange	
C72	DN50	DIN 1864-2A	316L	Hygienic flange	

Model H300

Code	Description				
361	3 in	Tri-Clamp compatible	316L	Hygienic fitting	
664	DN76.1	ISO 2853 (IDF)	316L	Hygienic coupling	
679	DN80	DIN11864-1A	316L	Aseptic connection	
680	DN80	DIN11864-2A	316L	Aseptic connection	
685	DN80	DIN11851	316L	Hygienic coupling	
687	3s	IDF	316L	Hygienic fitting	Type CLF2 W
694	DN76	SMS 1145	316L	Hygienic coupling	
C69	DN80	DIN 1864-3A	316L	Hygienic flange	

Case options

Case options for H015, H100, and H200

Code	Case option
N	Standard case
P	Standard case with purge fittings 0.5 in (13 mm) NPT female

Case options for H300

Code	Case option
E	Enhanced case
F	3 in (76 mm) compact case retrofit installation (Face-to-Face extension mount)
P	Enhanced case with purge fittings (0.5 in (13 mm) NPT female)

Electronics interface

Model	Description
0	For integral mount 2400S transmitter
1	For extended mount 2400S transmitter
2	4-wire polyurethane-painted aluminum integral enhanced core processor for remote mount transmitters

Model	Description
3	4-wire stainless steel integral enhanced core processor for remote mount transmitters Not available for truck mount.
4	4-wire polyurethane-painted aluminum integral extended mount enhanced core processor for remote mount transmitters
5	4-wire extended mount stainless steel integral enhanced core processor for remote mount transmitters Not available for truck mount.
6	MVDSolo™; polyurethane-painted aluminum integral enhanced core processor (for OEMs) When electronics interface W, D, 6, 7, 8 or 9 is ordered with approval C, A, I, or Z, MVD Direct Connect™ I.S. barrier is supplied.
7	MVDSolo; stainless steel integral enhanced core processor (for OEMs) Not available for truck mount. When electronics interface W, D, 6, 7, 8 or 9 is ordered with approval C, A, I, or Z, MVD Direct Connect I.S. barrier is supplied.
8	MVDSolo; extended mount polyurethane-painted aluminum integral enhanced core processor (for OEMs) When electronics interface W, D, 6, 7, 8 or 9 is ordered with approval C, A, I, or Z, MVD Direct Connect I.S. barrier is supplied.
9	MVDSolo; extended mount stainless steel enhanced core processor (for OEMs) Not available for truck mount. When electronics interface W, D, 6, 7, 8 or 9 is ordered with approval C, A, I, or Z, MVD Direct Connect I.S. barrier is supplied.
C	For integral mount 1700/2700 transmitter
L	For integral mount standard finish FMT transmitter Must be ordered with transmitter; only available with case code N.
K	For integral mount improved-surface finish (64 Ra [1.6 μm]) FMT transmitter Must be ordered with transmitter; only available with case code N.
F	For integral mount 5700 transmitter
R	9-wire polyurethane-painted aluminum junction box
H	9-wire extended mount polyurethane-painted aluminum junction box
Z	Other electronic interface (4200 transmitter) - requires a selection from Other electronic interface .

Codes available by model

Model	Available codes																		
	H	R	D	W	K	L	C	A	Q	9	8	7	6	5	4	3	2	1	0
H025, H050, H100	H	R	D	W	K	L	U	A	Q	9	8	7	6	5	4	3	2	1	0
H200, H300	H	R	D	W			U	A	Q	9	8	7	6	5	4	3	2	1	0

Conduit connections

Code descriptions

Code	Description
A	M20 — no gland
B	0.5 in (13 mm) NPT — no gland Not available with approvals T, S or J on models H200S and H300S.
E	M20 — no gland; not available with electronics interface code Q, A, V, or B in combination with approval code T or S on models H200S-H300S
F	Brass/nickel cable gland - cable diameter 0.335 in (8.51 mm) to 0.394 in (10.01 mm) Not available with approvals T, S or J on models H200S and H300S.
G	Stainless steel cable gland - cable diameter 0.335 in (8.51 mm) to 0.394 in (10.01 mm) Not available with approvals T, S or J on models H200S and H300S.
H	Brass/nickel cable gland Not available with approvals T, S or J on models H200S and H300S.
J	Stainless steel cable gland Not available with approvals T, S or J on models H200S and H300S.
K	JIS B0202 1/2G - no gland Only available with approval code M, T, or S.
L	Japan - brass nickel gland Only available with approval code M, T, or S.
M	Japan - stainless cable gland Only available with approval code M, T, or S.
N	JIS B0202 3/4G - no gland Only available with approval code M, T, or S.
O	Japan - brass nickel gland Only available with approval code M, T, or S.
P	Japan - stainless cable gland Only available with approval code M, T, or S.

Codes available by model

Model	Available codes													
	P	O	N	M	L	K	J	H	G	F	E	B	A	
All models with electronics interface codes 0, 1, C, K, and L													A	
All models with electronics interface codes 2, 3, 4, 5, Q, A, V, and B				M	L	K			G	F	E	B		
All models with electronics interface codes 6, 7, 8, 9, W, D, Y, and E									G	F	E	B		
All models with electronics interface codes R and H	P	O	N				J	H					A	

Approvals

Code	Description
A	CSA (US and Canada): Class 1, Division 1
C	CSA (Canada only)
G	Country Specific Approval – Requires a selection from Country specific approvals
I	IECEX Zone 1
J	Hardware ready for TIIS approval; EPM Japan only.
M	Micro Motion Standard; no approval; without CE/EAC markings
N	Micro Motion Standard / PED compliant; no approval; with CE/EAC markings
S	TIIS – T3 Temperature Classification; not available for quote outside of Japan
P	NEPSI
S	TIIS - T3 Temperature Classification; not available for quote outside of Japan
T	TIIS - T4 Temperature Classification; not available for quote outside of Japan
V	ATEX - Equipment Category 3 (Zone 2)
Z	ATEX - Equipment Category 2 (Zone 1) / PED compliant
2	CSA (US and Canada): Class 1, Division 2
3	IECEX Zone 2

Codes available by model

Model	Codes available													
	3	2	Z	V	T	S	N	M	J	I	G	C	A	
All models with electronics code 0, 1, L, and K	3	2		V			N	M			G			
All models with electronics code Q, A, V, B, C, R, and H			Z		T	S	N	M	J	I	G	C	A	
All models with electronics code 6, 7, 8, 9, W, D, Y, and E			Z				N	M		I	G	C	A	
All models with electronics code 2, 3, 4, and 5			Z				N	M		I	G		A	

Languages

Code	Language option
A	Danish CE requirements document and English installation manual
D	Dutch CE requirements document and English installation manual
E	English installation manual
F	French installation manual
G	German installation manual

Code	Language option
H	Finnish CE requirements document and English installation manual
I	Italian installation manual
J	Japanese installation manual
M	Chinese installation manual
N	Norwegian CE requirements document and English installation manual
P	Portuguese installation manual
S	Spanish installation manual
W	Swedish CE requirements document and English installation manual
B	Hungarian CE requirements document and English installation manual
K	Slovak CE requirements document and English installation manual
T	Estonian CE requirements document and English installation manual
U	Greek CE requirements document and English installation manual
L	Latvian CE requirements document and English installation manual
V	Lithuanian CE requirements document and English installation manual
Y	Slovenian CE requirements document and English installation manual

Future option 1

Code	Future option 1
Z	For H025F, H050F, H100F, H200F, H300F; reserved for future use

Calibration

Code	Calibration option
Z	$\pm 0.15\%$ mass and 0.002 g/cm^3 (2 kg/m^3) density calibration
1	$\pm 0.10\%$ mass and 0.001 g/cm^3 (1 kg/m^3) density calibration Not available on all models
K	$\pm 0.10\%$ mass and 0.0005 g/cm^3 (0.5 kg/m^3) density calibration Not available on all models
2	$\pm 0.05\%$ mass and 0.0005 g/cm^3 (0.5 kg/m^3) density calibration Not available on all models

Measurement application software

Code	Factory options
Z	No measurement application software

Factory options

Code	Factory option
Z	Standard product
X	ETO product
R	Restocked product (if available)

Certificates, tests, calibrations, and services

These option codes can be added to the end of the model code if needed, but no code is required when none of these options is selected.

There may be additional options or limitations depending on total meter configuration. Contact a sales representative before making your final selections.

Material quality examination tests and certificates

Select any from this group.

Code	Factory option
MC	Material inspection certificate 3.1 (supplier lot traceability per EN 10204)
NC	NACE certificate 2.1 (MR0175 and MR0103)

Radiographic testing

Select only one from this group.

Code	Factory option
RE	X-ray package 3.1 (radiographic examination certificate; weld map; radiographic inspection NDE qualification)
RT	X-ray package 3.1 (radiographic examination certificate with digital image; weld map; radiographic inspection NDE qualification)

Pressure testing

Code	Factory option
HT	Hydrostatic test certificate 3.1

Dye penetrant examination

Code	Factory option
D1	Dye penetrant test package 3.1 (Liquid Dye Penetration NDE Qualification): <ul style="list-style-type: none"> ■ Sensor only (H025-H200) ■ Sensor process connection only (H300)

Weld examination

Code	Factory option
WP	Weld procedure package (weld map, weld procedure specification, weld procedure qualification record, welder performance qualification)

Positive material testing

Select only one from this group.

Code	Factory option
PM	Positive material test certificate 3.1 without carbon content
PC	Positive material test certificate 3.1 including carbon content

Special cleaning

Code	Factory option
O2	Declaration of compliance oxygen service 2.1

Accredited calibration

Code	Factory option
IC	ISO17025 accredited calibration and certificates (9 points total)

Special calibration options

Select either none, CV, or CV with one of the additional verification point options.

For all special calibration options, the minimum flow rate for any verification point is 5% of sensor nominal flow rate.

Code	Factory option
CV	Custom verification (alter original verification points)
01	Add one additional verification point
02	Add two additional verification point
03	Add three additional verification point
06	Add up to six additional verification points
08	Add up to eight additional verification points
16	Add up to 16 additional verification points

Sensor completion options

Select any from this group.

Code	Factory option
WG	Witness general
SP	Special packaging

Country specific approvals

Select one from the following if approval code G is selected.

All of the following codes are:

- Only available with approval code G.
- Not available with electronics code 0, 1, K, or L.

Code	Factory option
R1	EAC Zone 1 – Hazardous Approval
R3	EAC Zone 2 – Hazardous Approval
B1	INMETRO Zone 1 – Hazardous Approval
B3	INMETRO Zone 2 – Hazardous Approval

Other electronic interface

Available only when approvals option G is selected.

Code	Factory option
UA	4200 integral mount aluminum housing

Emerson Automation Solutions

Worldwide Headquarters
7070 Winchester Circle
Boulder, Colorado USA 80301
T: +1 800-522-6277
T: +1 303-527-5200
F: +1 303-530-8459
Mexico: 52 55 5809 5473
Argentina: 54 11 4733 5400
Brazil: 55 15 3413 8888
Chile: 56 22 4310 7432

Emerson Automation Solutions

Central Europe: +41 41 7686 111
Eastern Europe: +41 41 7686 111
Dubai: +971 4 811 8100
Abu Dhabi: +971 2 697 2000
Austria: +43 2236 607-0
France: 0800 917 901
Germany: +49 (0) 2173 3348 0
Italy: 8008 77334
The Netherlands: +31 318 495 555
Belgium: +32 2 716 77 11
Spain: 900 901 986
U.K.: 0870 240 1978
Russian/CIS: +7 495 995 9559

Emerson Automation Solutions

Australia: (61) 3 9721 0200
China: (86) 21 2892 9000
India: (91) 22 6662 0566
Japan: (81) 3 5769 6803
South Korea: (82) 31 8034 0000
Singapore: (65) 6 363 7766

©2019 Micro Motion, Inc. All rights reserved.

The Emerson logo is a trademark and service mark of Emerson Electric Co. Micro Motion, ELITE, ProLink, MVD and MVD Direct Connect marks are marks of one of the Emerson Automation Solutions family of companies. All other marks are property of their respective owners.