

Micro Motion[®] Heavy Fuel Viscosity Meter (HFVM) Viscomaster[™]

High-performance multi-variable viscosity meter

World-wide marine-approved design for aggressive environments

- Continuous, multi-variable measurement of viscosity, density, and temperature
- Accurate measurement of viscosity ($\pm 1\%$ of full scale) and density ($\pm 1 \text{ kg/m}^3$)
- Optimized design that is insensitive to vibration, temperature, and pressure variations
- Durable Diamond-Like Carbon (DLC) coating that is resistant to friction, chemicals, impact, and mechanical damage

Superior multi-variable I/O and meter health

- Hazardous-area approved, head-mounted transmitter that supports local configuration and display
- Internal diagnostics for fast verification of meter health and installation

Installation flexibility and compatibility

- Direct-insertion design for inline measurement
- 4-20 mA, HART, and Modbus protocol connection to control systems and external devices
- Retrofit kits for replacing capillary and torsional meters
- Upgrades for 7829 Viscomaster systems



Compact Density Meter

Peak performance
precision density meter

Fork Density Meter

Direct insertion
density meter

Gas Density Meter

Fiscal gas
density meter

Specific Gravity Meter

Gas specific
gravity meter

Fork Viscosity Meter

High performance multi-variable
viscosity meter

Heavy Fuel Viscosity Meter
Viscomaster

Multi-variable marine and power HFO
viscosity meter



The Micro Motion HFVM

The HFVM measures liquid viscosity, density, and temperature in aggressive environments. These meters use vibrating fork technology for reliable direct-insertion measurement. HFVMs provide Heavy Fuel Oil (HFO)/Marine Gas Oil (MGO) combustion control, and oil-fired heater and boiler control.

Marine and power applications

Rugged, reliable, and low maintenance, these meters are the industry standard for HFO measurement applications.

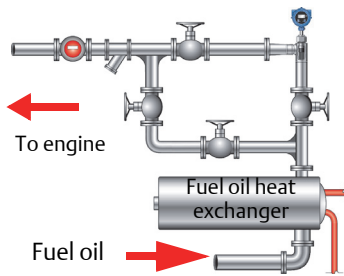

Application configurations

Integral HART I/O direct input measures external temperature, pressure, and flow to provide enhanced readings.

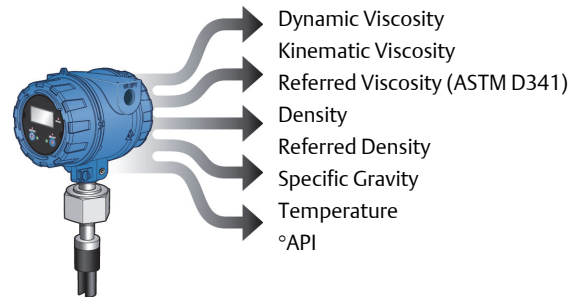

Retrofit capabilities

The HFVM has installation options for replacing capillary and torsional meters that give you the performance you need.

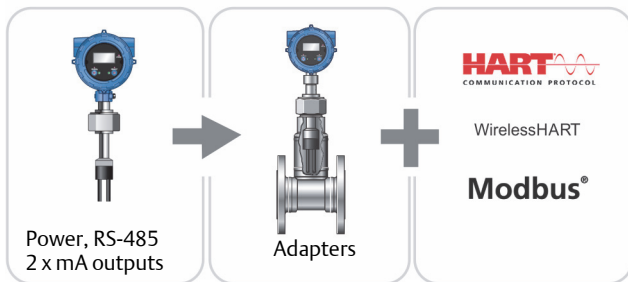

Integral transmitter

Supports 4-20 mA (analog), HART, WirelessHART®, and Modbus RS-485 communications.

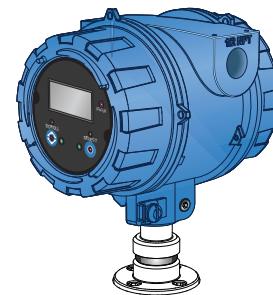

ProLink® III software

ProLink III is an easy-to-use interface where you can view key process variables and diagnostics data.

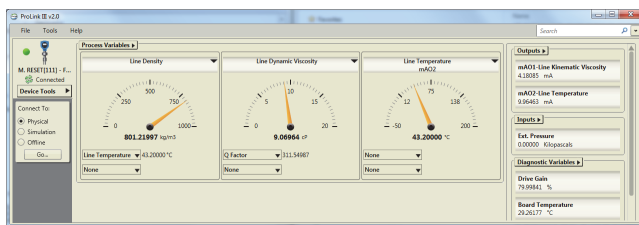

Meter diagnostics

Ensure measurement health through Known Density Verification (KDV), and other meter and installation diagnostic capabilities.



Operating principle

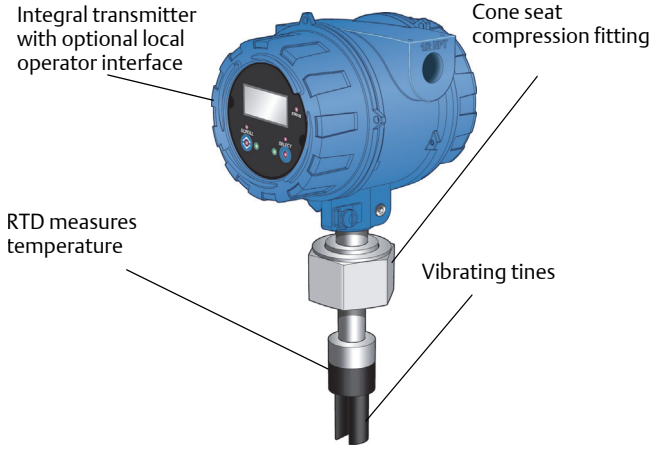

Fork vibration

- A fully welded fork assembly is inserted directly into the liquid to be measured.
- Using piezoelectricity, the fork tines vibrate at natural frequency.

Temperature measurement

- An integral Class B RTD measures the vibrating fork temperature.
- Micro Motion transmitters use this reading to optimize performance over a wide range of process conditions.

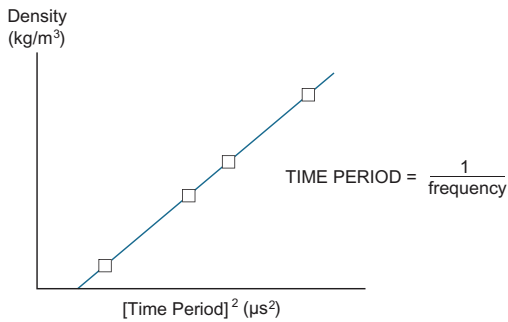

Density measurement

- The tines' natural frequency changes with the density of the surrounding liquid.
- Micro Motion transmitters accurately measure time period (1/frequency).
- Measured time periods are converted into density readings using meter calibration coefficients.

Viscosity measurement

- The bandwidth of the tines' natural frequency changes with the viscosity of the surrounding liquid.
- Micro Motion transmitters accurately measure bandwidth.
- Bandwidth measurements are converted into viscosity readings using meter calibration coefficients.

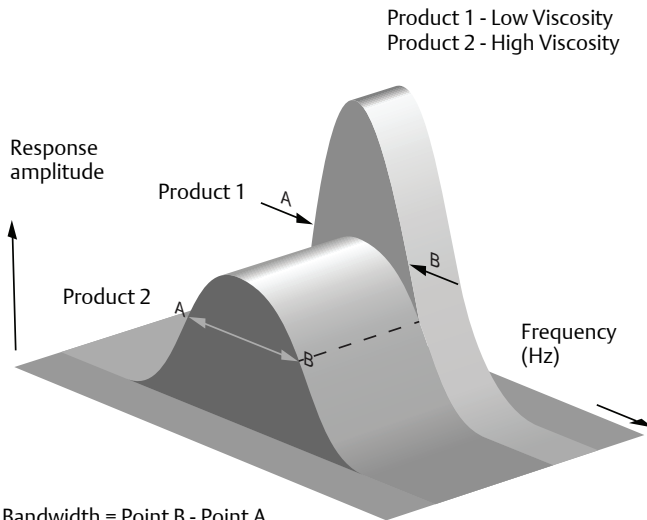

Bandwidth = Point B - Point A
 Resonant frequency = (Point A + Point B) / 2
 Quality factor = Resonant frequency / bandwidth

Performance specifications

Viscosity measurement

Specification	Value	
Calibration range and accuracy	Calibration code	Accuracy
	0.5 to 10 cP	±0.2 cP
	10 to 100 cP	±1% of calibration range maximum
Standard calibration range options	0.5 to 100 cP	
Repeatability	±0.5% of reading	

Density measurement (calibration code B only)

Specification	Value	
Accuracy	±1 kg/m ³	±0.001 g/cm ³
Operating density range	0 to 3000 kg/m ³	0 to 3.0 g/cm ³
Calibration range	600 to 1250 kg/m ³	0.6 to 1.25 g/cm ³
Repeatability	±0.1 kg/m ³	±0.0001 g/cm ³
Process temperature effect (corrected)	±0.1 kg/m ³ per °C	±0.0001 g/cm ³ per °C
Process pressure effect (corrected)	None	

Temperature measurement

Specification	Value	
Operating temperature range	-50 °C to +200 °C	-58 °F to +392 °F
Integral temperature measurement	<ul style="list-style-type: none"> ■ Technology: 100 Ω RTD ■ Accuracy: BS1904 Class, DIN 43760 Class B 	

Pressure ratings

Actual maximum operating pressures are limited by the process connection rating.

Specification	Value	
Maximum operating pressure	100 bar	1450 psi (cone-seated fitting)
Test pressure	Tested to 1.5 times the maximum operating pressure	
PED compliance	Not applicable	

Transmitter specifications

Transmitter features and process variables

	Feature		Process variables	
	Calibration code B	Calibration code R	Calibration code B	Calibration code R
Process measurement				
Viscosity measurement	Yes	Yes	Dynamic viscosity Kinematic viscosity	Dynamic viscosity Kinematic viscosity
Density measurement	Direct	Derived ⁽¹⁾	Density	Density ⁽²⁾
Two-phase flow detection	Yes	No	N/A	N/A
Internal temperature	Yes	Yes	Temperature	Temperature
Ignition quality	Yes	No	CCAI ⁽²⁾ CII ⁽²⁾	N/A
Measurement applications				
Referred viscosity ⁽³⁾	Yes	No	Referred viscosity (dynamic or kinematic) ⁽²⁾	N/A
API referral	Yes	No	Referred density (API)	N/A
Measurement diagnostics				
Known Density Verification (KDV)	Yes	No	N/A	N/A

(1) Calculated from reference density and reference temperature using the API equations for crude oil.

(2) Derived value

(3) Three methods: ASTM D341 single-curve, ASTM D341 multi-curve, and matrix referral.

Transmitter I/O and communications

Typical application	Transmitter version	Output channels		
		A	B	C
Marine and power HFO combustion control, and oil-fired heater and boiler control	Analog	4-20 mA + HART	4-20 mA	RS-485/Modbus

Local display

Design	Features
Physical	<ul style="list-style-type: none"> ■ Segmented two-line LCD screen ■ Can be rotated on transmitter, in 90-degree increments, for ease of viewing ■ Suitable for hazardous area operation ■ Optical switch controls for hazardous area configuration and display ■ Glass lens ■ Three-color LED indicates meter and alert status
Functions	<ul style="list-style-type: none"> ■ View process variables ■ View and acknowledge alerts ■ Configure mA and RS-485 outputs ■ Supports Known Density Verification (KDV) ■ Supports multiple languages







Additional communication options

The following communications accessories are purchased separately from the meter.

Type	Description
WirelessHART [®]	Wireless HART is available via the THUM adapter
HART [®] Tri-Loop	Three additional 4–20 mA outputs are available via connection to a HART Tri-Loop

Hazardous area approvals

Ambient and process temperature limits are defined by temperature graphs for each meter and electronics interface option. Refer to the detailed approval specifications, including temperature graphs for all meter configurations, and safety instructions. See the product page at the Micro Motion web site at www.micromotion.com.

ATEX	
Zone 1 Flameproof	<p>Without display</p> <p>   ■ II 1/2G Ex d IIC T6 Ga/Gb</p>
Zone 2	<p>Without display</p> <p>  ■ II 3G Ex nA IIC T6 Gc</p>
	<p>With display</p> <p>  ■ II 3G Ex nA IIC T4 Gc</p>
CSA	
Explosion proof	<p>Without display</p> <ul style="list-style-type: none"> ■ Class I, Division 1, Groups C & D ■ Class I, Division 2, Groups A, B, C & D ■ Class II, Division 1, Groups E, F & G
	<p>With display</p> <ul style="list-style-type: none"> ■ Class I, Division 2, Groups A, B, C & D
IECEX	
Zone 1 Flameproof	<p>Without display</p> <ul style="list-style-type: none"> ■ Ex d IIC T6 Ga/Gb
Zone 2	<p>Without display</p> <ul style="list-style-type: none"> ■ Ex nA IIC T6 Gc
	<p>With display</p> <ul style="list-style-type: none"> ■ Ex nA IIC T4 Gc

Marine approval classifications

Marine approval	Country
Lloyd's Register	United Kingdom
Germanische Lloyd	Germany
Det Norske Veritas	Norway
Bureau Veritas	France
American Bureau of Shipping (pending)	USA
RINA (pending)	Italy
Nippo Kaiji Kyokai (pending)	Japan
Russian Maritime Register of Shipping (pending)	Russia
South Korean Register of Shipping (pending)	South Korea

Environmental specifications

Type	Rating	
Electromagnetic compatibility	All versions conform to the latest international standards for EMC, and are certified compliant with EN 61326	
Ambient temperature	-40 °C to +65 °C	-40 °F to +149 °F
Ingress protection rating	IP66/67, CSA Type 4	

Power requirements

Type	Description
DC power requirements	<ul style="list-style-type: none"> ■ 24 VDC, 0.65 W typical, 1.1 W maximum ■ Minimum recommended voltage: 21.6 VDC with 1000 ft of 24 AWG (300 m of 0.20 mm²) power-supply cable ■ At startup, the power source must provide a minimum of 0.5 A short-term current, 19.6 V minimum at the power input terminals

Physical specifications

Construction materials

Component	Material
Wetted parts	316L stainless steel
Tine finish	DLC (Diamond-Like Carbon) coated
Transmitter housing	Polyurethane-painted aluminum

Weight

Specification	Value	
Weight (typical)	6.7 kg	15 lbs

Dimensions

Use these dimensional drawings as a basic guideline for sizing and planning. For complete and detailed dimensional drawings, see the product drawings link at the Micro Motion online store at www.micromotion.com/onlinestore.

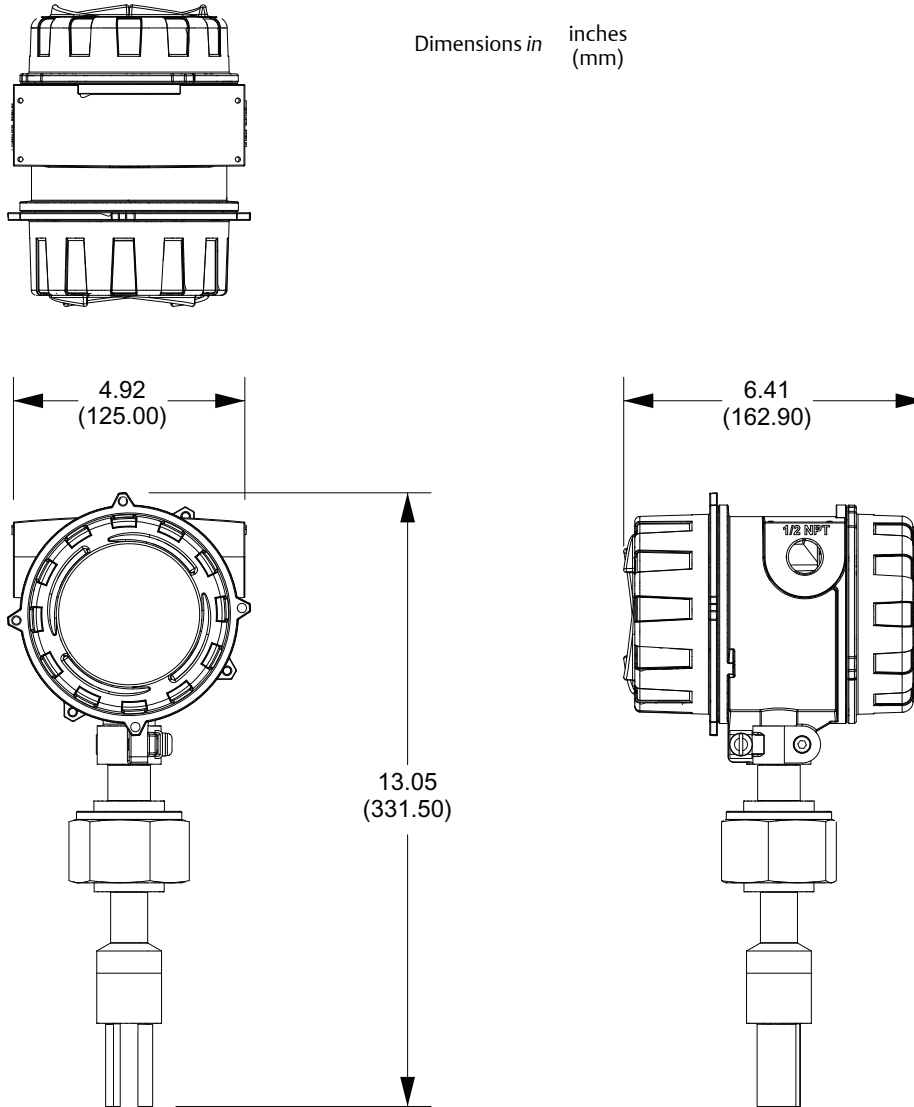

Installation and retrofit accessories

A variety of installation accessories are available for both inline and slipstream/bypass installations. Additionally, you can replace other viscosity measurement technologies using retrofit adapter kits. For more information on these installation accessories, see the Micro Motion Insertion Density and Viscosity Meter Accessories product data sheet available at www.micromotion.com.

Fuel heater control example

Most marine and land-based engine/burner applications use a fuel booster module to precondition the heavy fuel oil (HFO) prior to injection. These modules usually consist of a number of supply pumps fed by either HFO or MDO, a flow meter, inline filters to remove the impurities, and a holding/mixing tank.

Following the supply section, the fuel is usually sent to booster pumps that increase the flow rate up to a maximum of 20 m³/hr, and then through a series of liquid or electric heat exchangers to change the product viscosity for efficient combustion.

The following graphic shows different installation options for the HFVM in a fuel booster module.

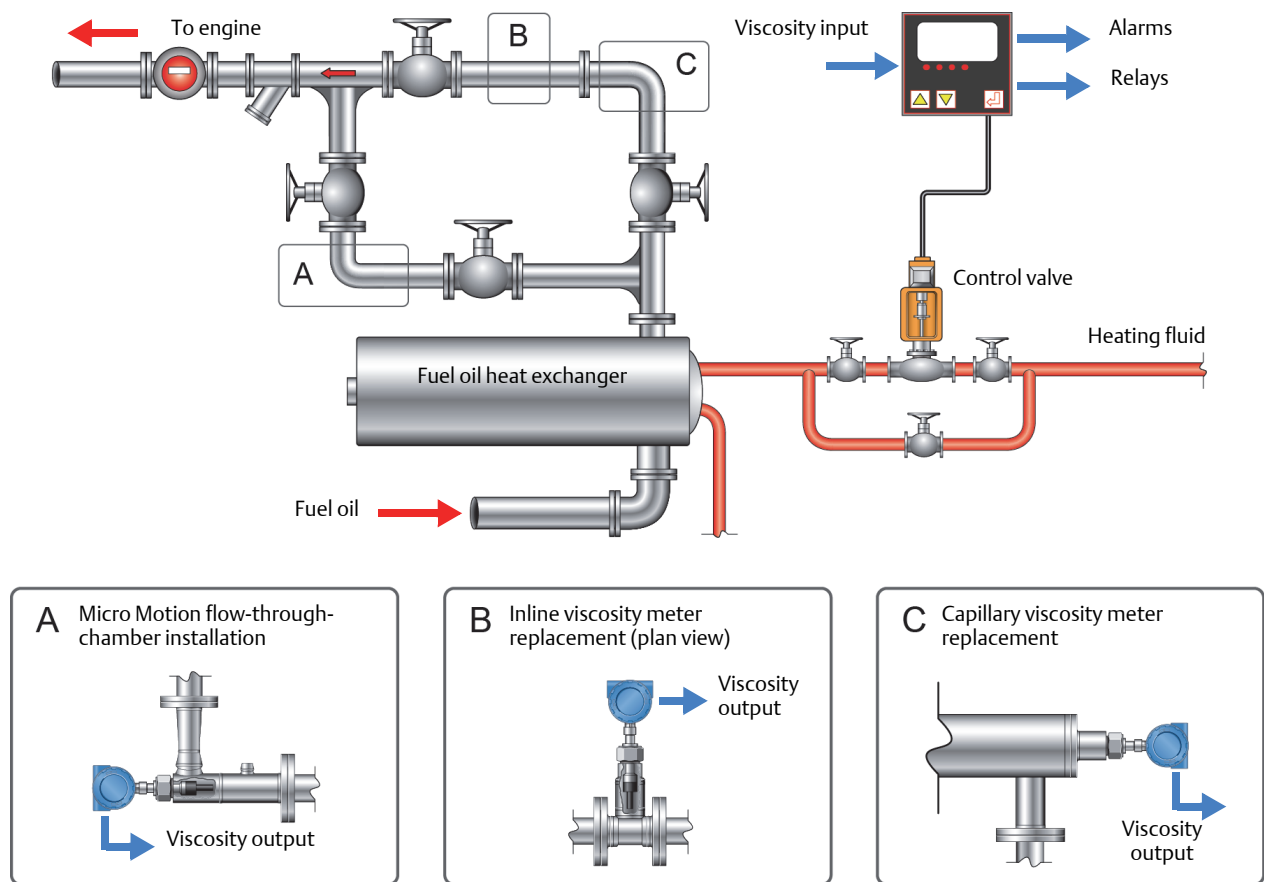

Ordering information

Model	Description
HFVM	Heavy Fuel Viscosity Meter (HFVM) Viscomaster
Code	Sensor calibration code and performance
1	Viscosity accuracy $\pm 0.2\text{cSt}$ (0-10cSt range) then $\pm 1\%$ FS, viscosity limit 100cSt
Code	Stem length
1	0 mm: no stem extension and with standard spigot
Code	Materials of wetted parts (including process connection)
L	316L stainless steel, Diamond-Like Carbon (DLC) coated tines
X	Special order (ETO) material of wetted parts
Code	Process connections
729	1-1/2 inch, cone-seat compression fitting, 316/316L
999	Special order (ETO) process connection
Code	Sensor calibration types
B	2-inch schedule 40 boundary
E	3-inch schedule 80 boundary
H	2-1/2 inch schedule 40 boundary
X	Special order (ETO) calibration type: Requires X factory option
Code	Transmitter housing option
A	Integral, aluminum alloy
Code	Transmitter outputs option
C	Integral transmitter, Channel A = mA + HART, Channel B = mA output, Channel C = RS485 Modbus
Code	Display option
Available with approvals codes M, 2, V and 3 only	
2	Integral two-line display (non-backlit)
Available with all approvals codes	
3	No display
Code	Approvals
M	Safe area - no hazardous area approval
2	CSA Class 1, Div 2 (US and Canada)
V	ATEX equipment category 3 (zone 2)
3	IECEX zone 2
A	CSA (US and Canada) explosion-proof
F	ATEX - zone 1 flameproof
I	IECEX - zone 1 flameproof
Code	Primary mA output (Channel A): Default process variable and scaling
H	Line viscosity (4 mA = 0 cSt, 20 mA = 25 cSt)
J	Line viscosity (4 mA = 0 cSt, 20 mA = 50 cSt)
E	Line viscosity (4 mA = 0 cSt, 20 mA = 100 cSt)
X	Special order (ETO) mA output configuration (customer data required): Requires X factory option

Code	Calibration code
B	0.5 to 100 cP viscosity and density calibration
R	5 to 50 cP viscosity calibration only
X	Special order (ETO) calibration code: Requires X factory option
Code	Language (manual and software)
Transmitter display language English	
E	English installation manual and English configuration manual
I	Italian installation manual and English configuration manual
M	Chinese installation manual and English configuration manual
R	Russian installation manual and English configuration manual
Transmitter display language French	
F	French installation manual and English configuration manual
Transmitter display language German	
G	German installation manual and English configuration manual
Transmitter display language Spanish	
S	Spanish installation manual and English configuration manual
Code	Future option 1
Z	Reserved for future use
Code	Conduit connections
Z	Standard 1/2-inch NPT fittings (no adapters)
B	M20 stainless steel adapters
Code	Factory options
Z	Standard product
X	Special order (ETO) product
Code	Special tests and certificates, tests, calibrations and services (optional)
Material quality examination tests and certificates	
MC	Material Inspection Certificate 3.1 (Supplier Lot Traceability per EN 10204)
NC	NACE Certificate 2.1 (MR0175 and MR0103)
Pressure testing	
HT	Hydrostatic Test Certificate 3.1 (Pressure-retaining parts only)
Dye penetrant examination	
D1	Dye Penetrant Test Package 3.1 (Sensor only; Liquid Dye Penetration NDE Qualification)

Weld examination	
WP	Weld Procedure Package (Weld Map, Weld Procedure Specification, Weld Procedure Qualification Record, Welder Performance Qualification)
Positive material testing (select only one from this group)	
PM	Positive Material Test Certificate 3.1 (without carbon content)
PC	Positive Material Test Certificate 3.1 (including carbon content)
Sensor completion options	
WG	Witness General
SP	Special Packaging
Instrument tagging	
TG	Instrument Tagging - customer information required (max. 24 characters)

**Emerson Process Management
Americas**

7070 Winchester Circle
Boulder, Colorado USA 80301

www.MicroMotion.com
www.Rosemount.com

I: +1 800 522 6277
T: +1 (303) 527 5200
F: +1 (303) 530 8459

Mexico T: 52 55 5809 5300
Argentina T: 54 11 4837 7000
Brazil T: 55 15 3413 8000
Venezuela T: 58 26 1300 8100

**Emerson Process Management
Europe/Middle East**

Central & Eastern Europe T: +41 41 7686 111
Dubai T: +971 4 811 8100
Abu Dhabi T: +971 2 697 2000
France T: 0800 917 901
Germany T: 0800 182 5347
Italy T: 8008 77334
The Netherlands T: +31 0 704 136 666
Belgium T: +32 2 716 77 11
Spain T: +34 913 586 000
U.K. T: 0870 240 1978
Russia/CIS T: +7 495 981 9811

**Emerson Process Management
Asia Pacific**

Australia T: (61) 3 9721 0200
China T: (86) 21 2892 9000
India T: (91) 22 6662 0566
Japan T: (81) 3 5769 6803
South Korea T: (82) 2 3438 4600
Singapore T: (65) 6 777 8211

©2015 Micro Motion, Inc. All rights reserved.

The Emerson logo is a trademark and service mark of Emerson Electric Co. Micro Motion, ELITE, ProLink, MVD, and MVD Direct Connect marks are marks of one of the Emerson Process Management family of companies. All other marks are property of their respective owners.

Micro Motion supplies this publication for informational purposes only. While every effort has been made to ensure accuracy, this publication is not intended to make performance claims or process recommendations. Micro Motion does not warrant, guarantee, or assume any legal liability for the accuracy, completeness, timeliness, reliability, or usefulness of any information, product, or process described herein. We reserve the right to modify or improve the designs or specifications of our products at any time without notice. For actual product information and recommendations, please contact your local Micro Motion representative.

